

Technical data
Hydraulic lift crane

LR 1280
Litronic®

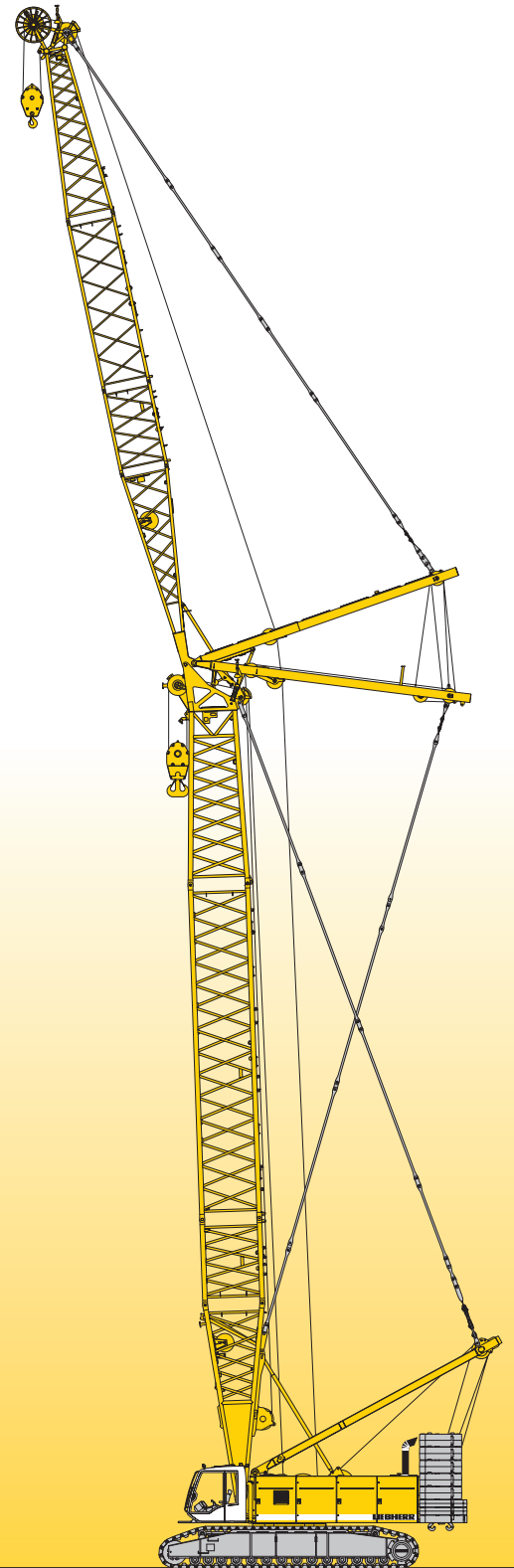

LIEBHERR

Dimensions

Basic machine with undercarriage

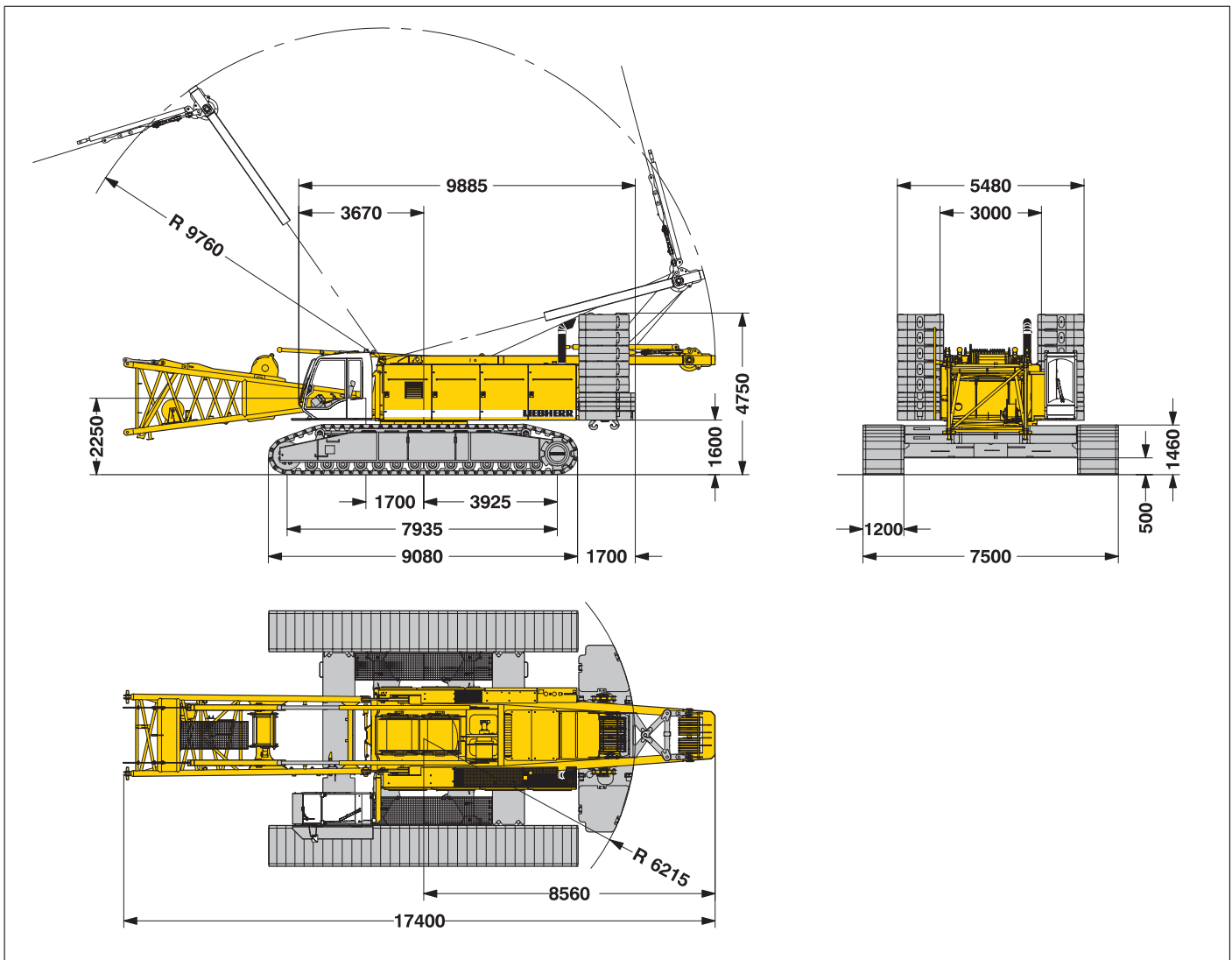

Operating weight

The operating weight includes the basic machine with crawlers, 2 main winches 150 kN and 20 m main boom, consisting of A-frame, boom foot (7 m), boom head (7 m), boom extension (6 m) 85.5 t basic counterweight, 36 t carbony counterweight and 300 t hook block.

Total weight _____ approx. 224.4 t

Ground pressure

Ground bearing pressure _____ 1.18 kg/cm²

Equipment

Main boom (No. 2220.xx) max. length _____ 90.2 m
 High reach (No. 2220.xx and 1916.xx) _____ 119.1 m
 Luffing jib (No. 1916.xx) max. length _____ 95.0 m
 Max. combination _____ boom 55.1 m and luffing jib 95.0 m
 Fixed jib (No. 1008.xx) _____ 11 m – 26 m
 Auxiliary jib 30 t lifting capacity

Remarks

1. The lifting capacities stated are valid for lifting operation only (corresponds with crane classification according to F.E.M. 1.001, crane group A1).
2. Crane standing on firm, horizontal ground.
3. The weight of the lifting device (hoisting ropes, hook block, shackle etc.) must be deducted from the gross lifting capacity to obtain a net lifting value.
4. Additional equipment on boom (e.g. boom walkways, auxiliary jib) must be deducted to get the net lifting capacity.
5. For max. wind speed please refer to lift chart in operator's cab or manual.
6. Working radii are measured from centre of swing and under load.
7. The lifting capacities are valid for 360 degrees of swing.
8. Calculation of stability under load is based on DIN 15019 / part 2 / chart 1 and ISO 4305 Table 1 + 2, tipping angle 4°.
9. The structures are calculated according to F.E.M. 1.001 – 1998 (EN 13001–2 / 2004).

Transport dimensions and weights

Basic machine and boom (No. 2220.xx)

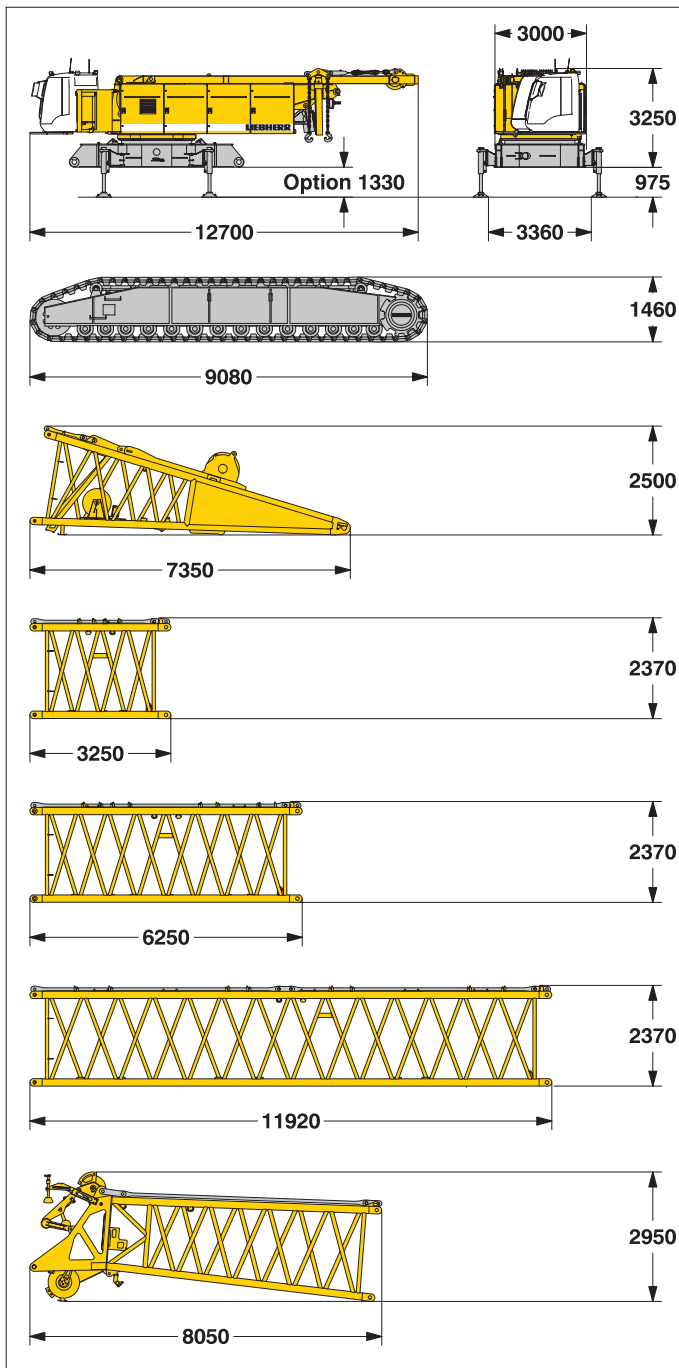

Basic machine

with A-frame, 2x 150 kN crane winches including wire ropes (max. 665 m), without crawlers, boom foot, basic counterweight and carbody counterweight

Width	mm	3000
Weight	kg	41600

Crawler

2x

Flat track shoes	mm	1200
Width	mm	1400
Weight	kg	20550

Boom foot (No. 2220.30)

Width	mm	2420
Weight*	kg	5620

Boom section (No. 2220.24)

3 m

Width	mm	2420
Weight*	kg	1130

Boom section (No. 2220.24)

6 m

Width	mm	2420
Weight*	kg	1875

Boom section (No. 2220.22)

11.7 m

Width	mm	2420
Weight*	kg	2885

Boom head (No. 2220.24)

Width	mm	2420
Weight*	kg	4690

Transport option

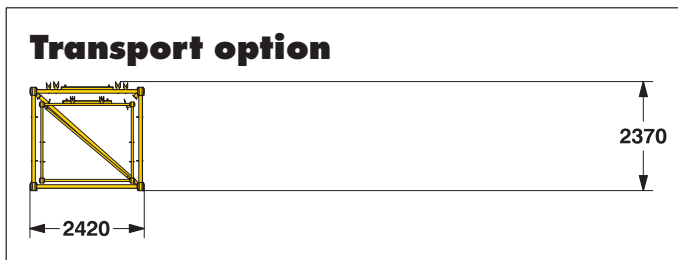

*) Including pendant straps

Boom transport option

No. 2220.xx/1916.xxx	m	11.7/12	6 / 6	3 / 3
Length	mm	12500	6250	3250
Weight*	kg	4135	2565	1680

Transport dimensions and weights

Luffing jib (No. 1916.xx)

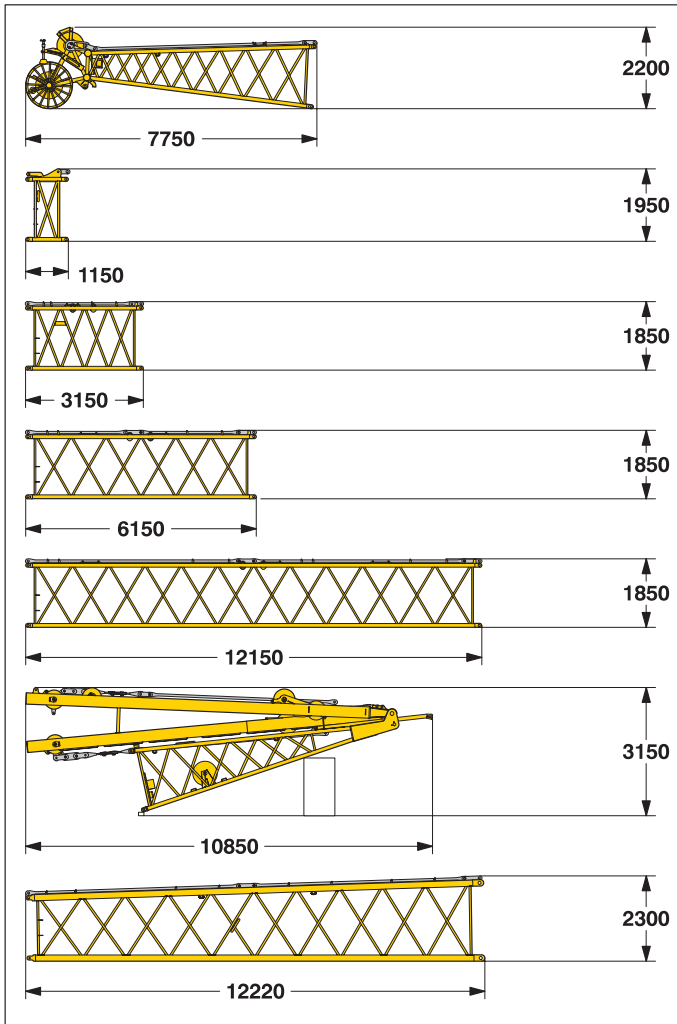

Luffing jib head (No. 1916.21)

Width	mm	2050
Weight*	kg	1550

L - boom jib section (No. 1916.22) **1 m**

Width	mm	2050
Weight*	kg	457

Luffing jib section (No. 1916.18) **3 m**

Width	mm	2050
Weight*	kg	550

Luffing jib section (No. 1916.18) **6 m**

Width	mm	2050
Weight*	kg	690

Luffing jib section (No. 1916.18) **12 m**

Width	mm	2050
Weight*	kg	1250

Luffing jib foot with A-frames (No. 1916.22)

Width	mm	2050
Weight*	kg	6400

L - boom section tapered (No. 2220/1916.22) **12 m**

Width	mm	2420
Weight*	kg	2635

Fixed jib (No. 1008.xx)

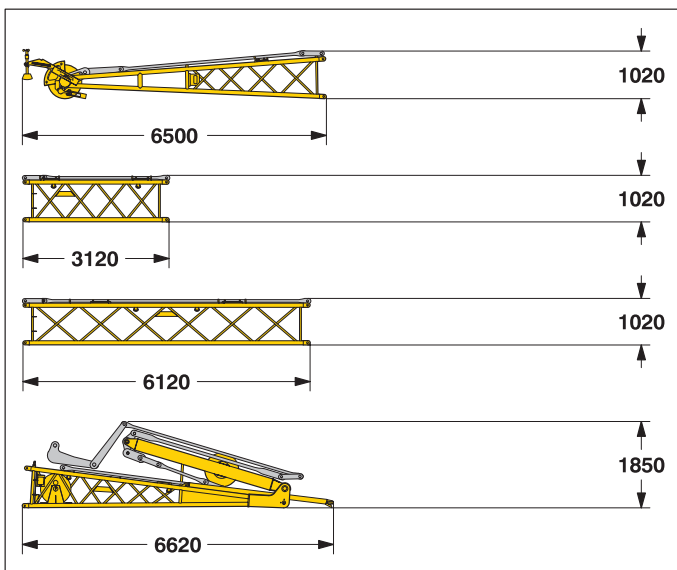

Fixed jib head (No. 1008.20)

Width	mm	1140
Weight*	kg	935

Fixed jib section (No. 1008.17) **3 m**

Width	mm	1100
Weight*	kg	300

Fixed jib section (No. 1008.17) **6 m**

Width	mm	1100
Weight*	kg	460

Fixed jib foot with A-frame (No. 1008.20)

Width	mm	1500
Weight*	kg	1950

*) Including pendant straps

Transport dimensions and weights

Counterweights

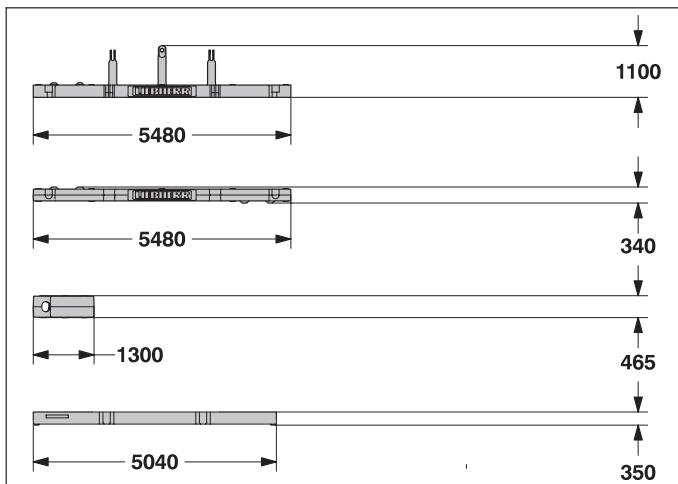

Counterweight **1x**

Width	mm	1660
Weight	kg	13300

Counterweight **2x**

Width	mm	1660
Weight	kg	10600

Counterweight **10x**

Width	mm	1360
Weight	kg	5100

Carbody counterweight **4x**

Width	mm	1140
Weight	kg	9000

Mid fall (option)

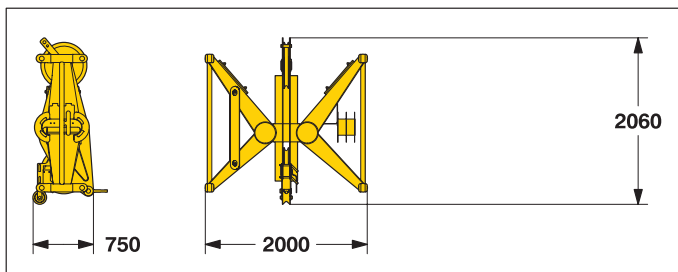

Mid fall section (No. 1916.32) **0.5 m**

Width	mm	750
Weight	kg	715

Hooks

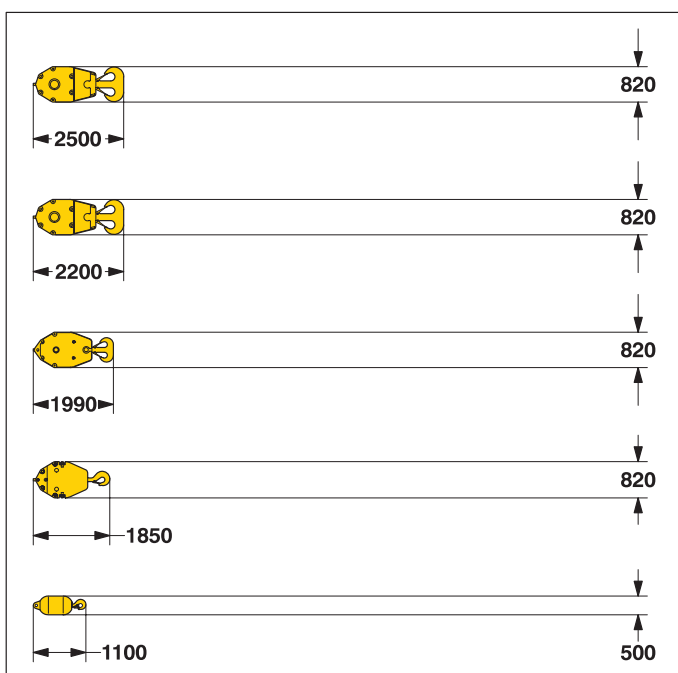

300 t hook block - 11 sheaves

Width	mm	880 — 1230
Weight	kg	3200 — 5500

150 t hook block - 5 sheaves

Width	mm	500 — 660 — 820
Weight	kg	1600 — 2800 — 4000

100 t hook block - 3 sheaves

Width	mm	340 — 480 — 620
Weight	kg	1100 — 2050 — 3000

50 t hook block - 1 sheave

Width	mm	280 — 410 — 540
Weight	kg	800 — 1600 — 2400

16 t single hook

Width	mm	500
Weight	kg	900

Technical description



Engine

Power rating according to ISO 9249, 450 kW (612 PS) at 1900 rpm
Engine type — Liebherr D 9508 A7
Fuel tank — 900 l capacity with continuous level indicator and reserve warning
Engine complies with NRMM exhaust certification EPA / CARB Tier 3 and 97/68 EC Stage III



Hydraulic system

An axial displacement pump supplies the open loop hydraulic system for boom luffing, jib luffing and travel. The main hoist winches and swing are operated in a closed loop system. All functions can be operated simultaneously. To minimize peak pressure an automatic working pressure cut-off is integrated in a pump. All filters are electronically monitored. The use of synthetic environmentally friendly (biodegradable) oils is possible. Working pressure — max. 350 bar
Oil tank capacity — 900 l



Luffing jib winch

Line pull — max. 105 kN
Rope diameter — 20 mm
Jib luffing — 51 sec. from 15° to 78°



Boom winch

Line pull — max. 217 kN
Rope diameter — 24 mm
Boom up — 137 sec. from 15° to 86°



Swing

Consists of rollerbearing with external teeth, swing drive with fixed axial piston hydraulic motor, spring loaded and hydraulically released multi-disc holding brake, planetary gearbox and pinion. Both swing modes are possible – speed control or free swing. A multi-disc holding brake acts automatically at zero swing motion. Swing speed from 0 – 1.8 rpm continuously variable.



Main winches

Line pull (1st layer) — max. 215 kN
Line pull (7th layer) — 150 kN
Rope diameter — 28 mm
Drum diameter — 730 mm
Rope speed m/min — 0 – 138
Rope capacity in 7 layers — 570 m
The winches are outstanding in their compact design and easy assembly. Propulsion is via a planetary gearbox in an oil bath. Load support by the hydraulic system; additional safety factor provided by a spring loaded, multi-disc holding brake. The main winches use pressure controlled, variable flow hydraulic motors. This system features sensors that automatically adjust oil flow to provide max. winch speed depending on load. Option – winch with freefall system: Clutch and braking functions on the freefall system are provided by a compact designed, low wear and maintenance free multi-disc brake.



Crawlers

Propulsion through axial piston motor, hydraulically released spring loaded multi-disc brake, crawler tracks, hydraulic chain tensioning device. Flat track shoes — 1200 mm
Drive speed — 0 – 1.4 km/h



Control

The control system – developed and manufactured by Liebherr – is designed to withstand extreme environmental conditions such as temperature, vibration and electromagnetic interference and to meet all requirements that are needed in heavy duty crane operation. Complete machine operating data are shown on a high resolution display. Standard operational information is displayed by means of graphical symbols, fault indications are displayed in plain text (more than 15 languages available). The cranes are equipped with proportional control for all main movements, which can be carried out simultaneously. The crane is operated with 2 multi-directional joysticks, the right for winch I and boom, the left for winch II and swing control. Option: Bi-directional double T-levers for simultaneous boom and luffing jib operation. The crawlers are activated by the two central foot pedals. Additionally, hand levers can be attached to the pedals. Remote control for assembly of counterweight and boom hinge pins.



Noise emission

Noise emissions correspond with 2000/14/EC directive on noise emission by equipment used outdoors.

Boom combinations

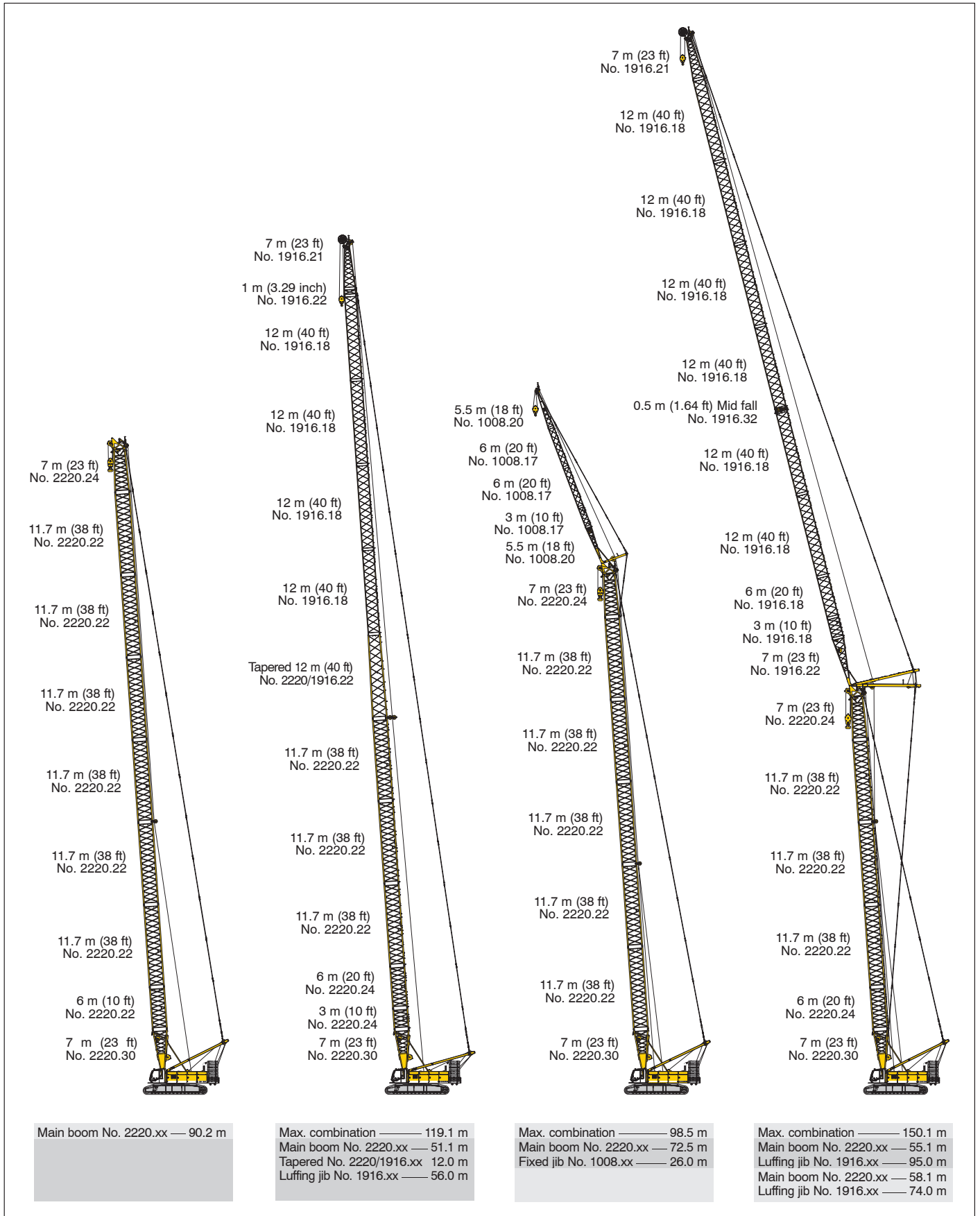

Self assembly system

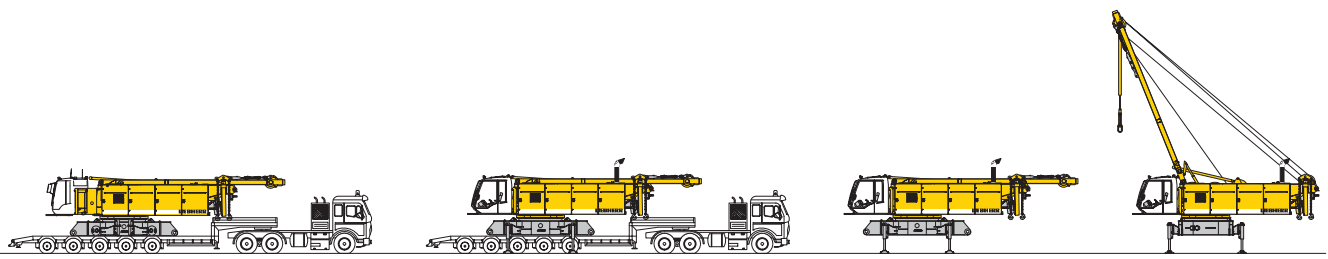

Unloading of basic machine

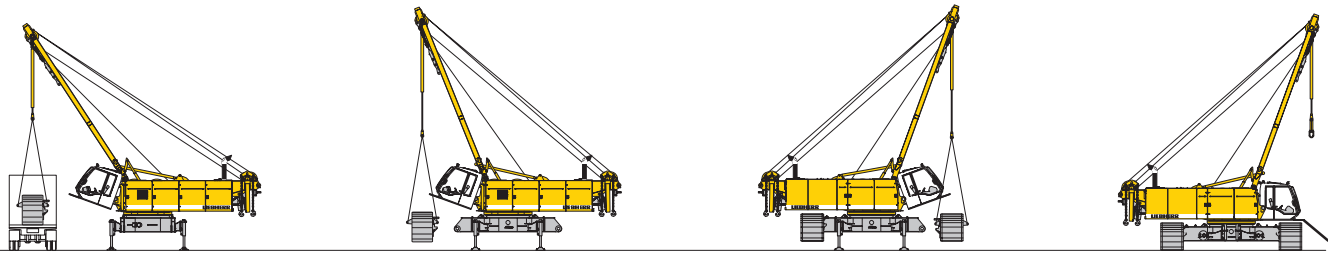

Unloading and assembly of crawlers

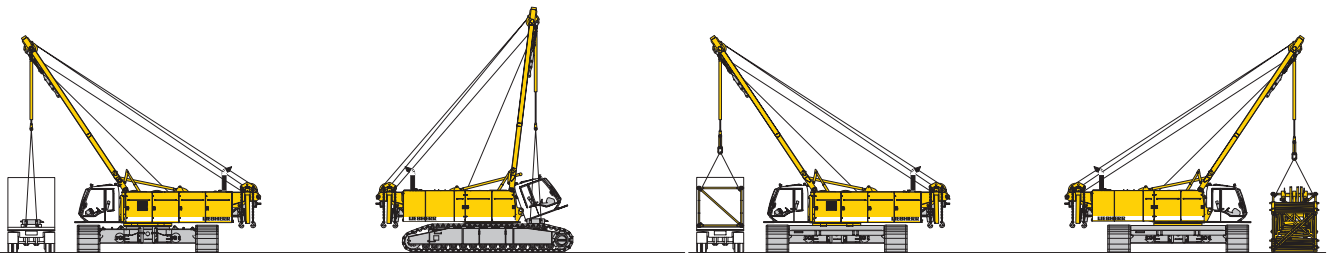

Unloading and assembly of carbody counterweight

Unloading and assembly of boom

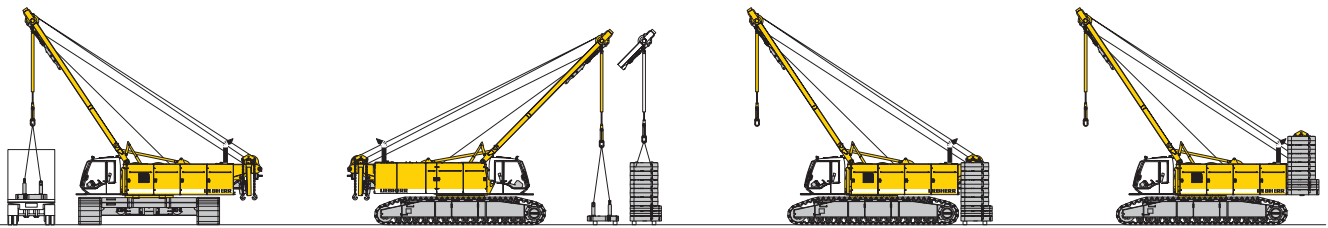

Unloading and assembly of counterweight



Unloading and assembly of boom foot

Erecting of main boom to working position

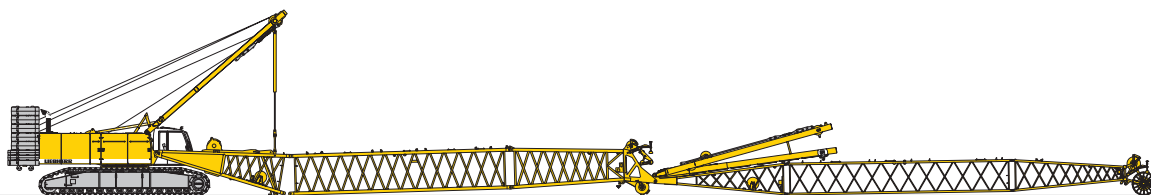

Assembly of boom

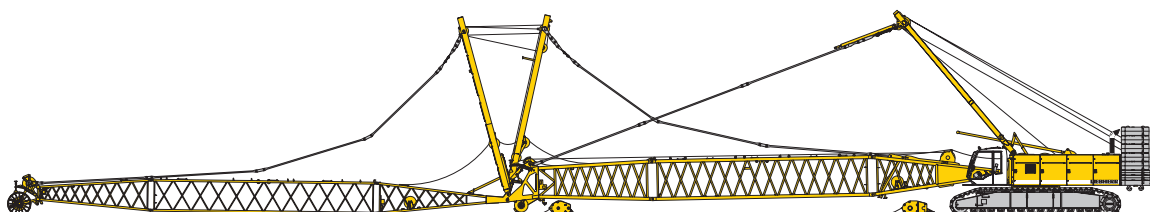

Reeving of hoist and luffing jib ropes

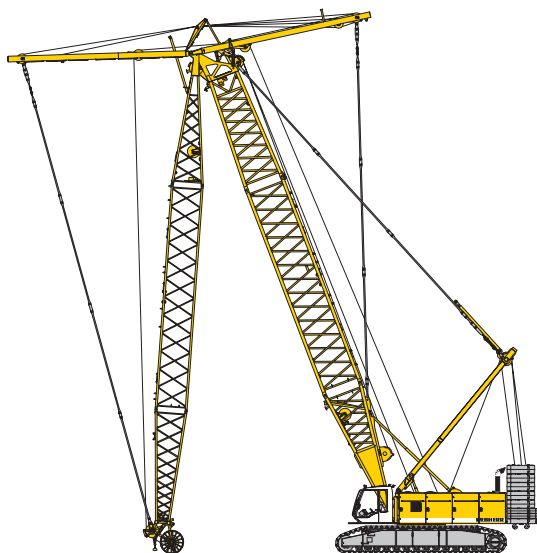

Erecting of main boom and luffing jib

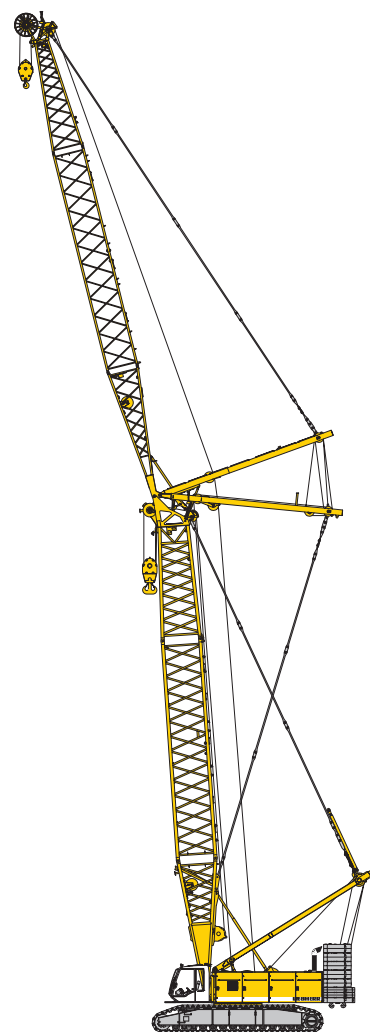

Working position

Lift chart for main boom (No. 2220.xx)

Capacities in metric tons for boom lengths (20 m – 90.2 m) – with 150 kN winches
85.5 t counterweight and 36.0 t carbody counterweight

Radius	Boom length in (m)													Radius
	20	25.7	31.7	37.4	43.4	49.1	55.1	60.8	66.8	72.5	78.5	84.2	90.2	
(m)	t	t	t	t	t	t	t	t	t	t	t	t	t	(m)
4.3	280.0													4.3
5	265.4	256.6												5
6	231.8	225.5	205.4	188.7	173.6									6
7	202.4	187.3	172.4	160.2	148.9	139.4	120.5							7
8	171.6	159.6	148.4	139.0	130.2	122.6	115.4	96.7	80.9	65.1				8
9	148.0	138.8	130.0	122.6	115.4	109.3	103.3	92.1	78.4	64.7	59.4	48.4		9
10	130.0	122.7	115.5	109.5	103.5	98.4	93.4	88.9	74.9	61.6	58.3	47.9	40.9	10
12	102.0	99.2	94.2	89.9	85.5	81.8	78.0	74.6	63.3	57.2	56.0	45.6	39.1	12
14	81.7	82.0	79.2	75.9	72.5	69.6	66.6	63.9	61.1	52.1	51.9	43.5	37.7	14
16	67.7	68.0	67.8	65.5	62.7	60.3	57.8	55.6	53.3	48.4	48.4	41.5	35.9	16
18	57.5	57.9	57.7	57.4	55.0	53.0	50.9	49.0	47.0	44.4	43.3	39.9	34.5	18
20	49.6	50.1	49.9	49.7	48.9	47.1	45.2	43.6	41.8	40.2	38.3	37.1	33.3	20
22		44.0	43.8	43.6	43.3	42.2	40.6	39.1	37.5	36.1	34.6	33.2	30.6	22
24		39.0	38.8	38.7	38.3	38.0	36.6	35.3	33.8	32.5	31.1	29.9	28.3	24
26		34.8	34.8	34.6	34.2	33.9	33.3	32.0	30.7	29.5	28.2	27.0	25.8	26
28			31.3	31.2	30.8	30.5	30.1	29.2	28.0	26.8	25.6	24.5	23.4	28
30			28.3	28.3	27.9	27.6	27.1	26.8	25.6	24.5	23.4	22.3	21.2	30
32			25.7	25.8	25.4	25.1	24.6	24.3	23.5	22.5	21.4	20.4	19.3	32
34				23.5	23.2	22.9	22.4	22.1	21.6	20.6	19.6	18.6	17.6	34
36				21.6	21.3	21.0	20.5	20.1	19.7	19.0	18.0	17.1	16.1	36
38				19.8	19.5	19.3	18.8	18.4	17.9	17.5	16.5	15.6	14.7	38
40					18.0	17.7	17.3	16.9	16.4	16.0	15.2	14.3	13.4	40
44						15.1	14.7	14.3	13.8	13.4	12.9	12.1	11.2	44
48						12.9	12.5	12.2	11.7	11.3	10.7	10.2	9.3	48
50							11.6	11.2	10.7	10.3	9.8	9.3	8.5	50
55							9.5	9.2	8.7	8.3	7.8	7.3	6.6	55
60								7.4	7.0	6.6	6.1	5.7	5.1	60
65									5.6	5.2	4.7	4.3	3.7	65
70										4.0	3.5	3.0	2.5	70
75											2.4	2.0	1.5	75
80												1.1		80

Above lift chart is for reference only. For actual lift duty please refer to lift chart in operator's cab or manual.
Capacities over 280 t require a special heavy duty boom head.

L – boom high reach (No.2220 / 1916.xx) **74.1 m - 119.1 m**

Working range 86° - 15°

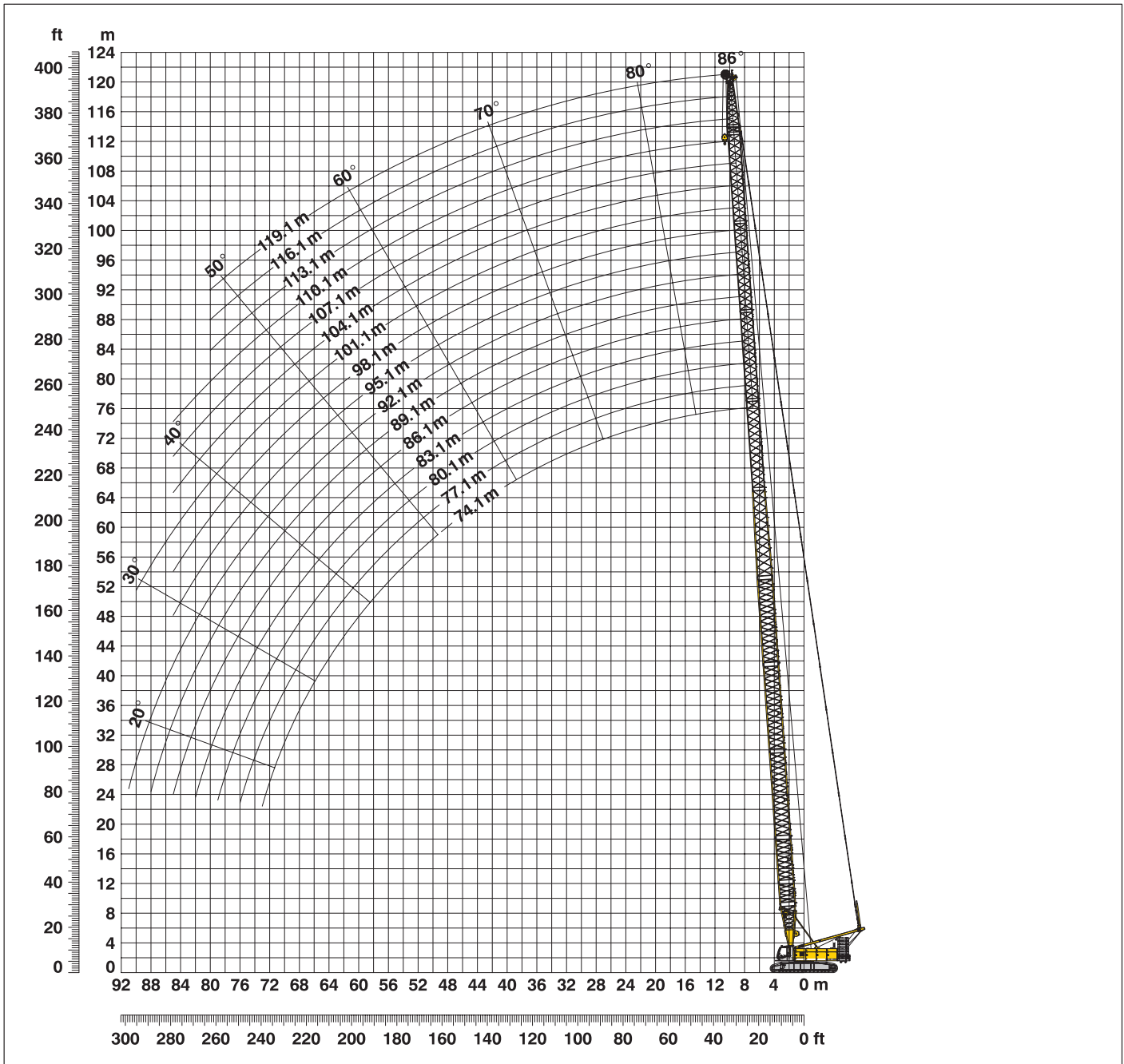

L – boom configuration with 51.1 m main boom (No. 2220.xx / No. 1916.xx)

Configuration for L – boom lengths (74.1 m – 119.1 m)

Configuration	Length	Amount of boom and luffing jib extensions															
		74.1	77.1	80.1	83.1	86.1	89.1	92.1	95.1	98.1	101.1	104.1	107.1	110.1	113.1	116.1	119.1
Boom foot	7.0 m	1	1	1	1	1	1	1	1	1	1	1	1	1	1	1	1
Boom insert	3.0 m	1	1	1	1	1	1	1	1	1	1	1	1	1	1	1	1
Boom insert	6.0 m	1	1	1	1	1	1	1	1	1	1	1	1	1	1	1	1
Boom insert	11.7 m	3	3	3	3	3	3	3	3	3	3	3	3	3	3	3	3
Tapered	12.0 m	1	1	1	1	1	1	1	1	1	1	1	1	1	1	1	1
Luffing insert	3.0 m	1		1		1		1		1		1		1		1	
Luffing insert	6.0 m		1	1		1	1		1	1		1	1		1	1	
Luffing insert	12.0 m				1	1	1	1	2	2	2	2	3	3	3	3	4
Luffing jib head	8.0 m	1	1	1	1	1	1	1	1	1	1	1	1	1	1	1	1
Max. L – boom length (m)		74.1	77.1	80.1	83.1	86.1	89.1	92.1	95.1	98.1	101.1	104.1	107.1	110.1	113.1	116.1	119.1

Lift chart for L – boom (No. 2220 / 1916.xx)

Main boom length 51.1 m

Capacities in metric tons
85.5 t counterweight and 36.0 t carbody counterweight

Radius	Boom length in (m)									Radius
	74.1	80.1	86.1	92.1	98.1	104.1	110.1	116.1	119.1	
(m)	t	t	t	t	t	t	t	t	t	(m)
7.4	54.9									7.4
8	54.9	45.5								8
9	54.0	45.1	38.2	31.4						9
10	53.1	43.7	37.4	30.8	24.7	20.6	16.8			10
12	50.8	42.1	35.1	28.2	23.0	19.5	16.1	10.1	9.1	12
14	47.1	39.0	32.8	26.5	21.7	18.3	15.2	9.5	8.6	14
16	41.2	36.4	30.9	24.7	20.1	17.2	11.6	9.0	8.2	16
18	37.1	33.1	28.4	23.4	19.1	16.3	11.0	8.5	7.8	18
20	33.3	30.9	26.6	21.9	17.9	15.5	10.6	8.1	7.4	20
22	27.9	27.4	25.1	20.8	16.9	11.6	10.0	7.8	7.1	22
24	27.0	25.2	23.3	19.8	16.2	11.0	9.5	7.4	6.8	24
26	25.0	23.5	21.9	18.9	15.5	10.6	9.2	7.1	6.5	26
28	23.3	21.5	20.8	18.1	13.1	10.3	8.9	6.9	6.4	28
30	21.9	19.8	19.5	17.5	12.6	10.0	8.7	6.7	6.2	30
32	20.4	18.5	18.4	16.6	12.2	9.7	8.5	6.5	6.0	32
34	18.8	17.4	17.5	15.8	11.8	9.5	8.4	6.3	5.9	34
36	17.4	16.2	16.7	15.2	11.4	9.3	8.1	6.2	5.7	36
38	16.4	15.2	15.5	14.0	11.1	9.2	7.8	6.1	5.6	38
40	15.3	13.8	13.4	13.1	10.9	9.0	7.5	6.0	5.5	40
42	13.6	13.6	12.7	12.2	10.4	8.9	7.2	6.0	5.3	42
44	12.7	12.6	12.1	11.4	9.9	8.7	7.0	5.9	5.2	44
46	12.0	11.7	11.5	10.7	9.5	8.4	6.8	5.9	5.1	46
48	11.4	10.9	10.6	10.2	9.2	8.1	6.6	5.8	5.0	48
50	10.6	10.3	9.8	9.5	8.9	7.8	6.4	5.7	4.9	50
55	8.8	8.7	8.3	7.9	7.6	7.2	6.1	5.4	4.6	55
60	7.5	7.3	7.0	6.8	6.4	6.0	5.4	5.1	4.3	60
65	6.4	6.3	6.0	5.7	5.5	5.1	4.6	4.2	3.8	65
70	5.4	5.4	5.1	4.9	4.6	4.3	4.0	3.4	3.2	70
75		4.6	4.3	4.1	3.9	3.6	3.3	2.8	2.7	75
80			3.6	3.4	3.2	3.0	2.7	2.2	2.1	80
85			2.9	2.8	2.6	2.2	2.2			85

Above lift chart is for reference only. For actual lift duty please refer to lift chart in operator's cab or manual.

Lift chart – luffing jib (No. 1916.xx)

Main boom angle 88°

Main boom 25.7 m

Radius (m)	Jib length in (m)							
	20	29	41	53	62	71	83	95
8.2	t	t	t	t	t	t	t	t
11	82.4							
13	75.6	58.1						
16	67.4	52.7	36.5					
17	56.1	46.2	32.7	23.4				
19	53.9	42.8	31.5	22.8	17.9			
22	46.1	40.1	28.8	21.6	17.3	12.2		
24	35.0	35.9	26.1	20.0	16.2	11.5	8.0	
26		32.6	24.8	19.2	15.5	11.0	7.7	5.1
28		28.1	23.6	18.5	15.1	10.6	7.4	5.0
30		26.9	22.7	17.9	13.9	10.3	7.2	4.9
32		24.1	21.9	17.4	13.5	10.1	7.0	4.7
42		15.1	20.5	16.9	13.3	9.8	6.8	4.6
55			15.3	13.6	11.8	8.8	6.1	3.9
60				9.3	9.5	7.8	5.1	3.2
70					8.2	7.4	4.8	2.9
80						5.8	4.1	2.3
85							3.5	

Main boom 37.4 m

Radius (m)	Jib length in (m)							
	20	29	41	53	62	71	83	95
8.6	t	t	t	t	t	t	t	t
11	71.5							
13	67.7	52.6						
16	60.7	49.5	33.3					
18	51.6	42.8	30.8	21.6				
20	45.8	40.3	28.1	20.6	16.5			
22	38.9	35.9	26.5	19.7	15.9	11.3		
26	34.5	32.3	25.0	18.8	15.3	10.8	7.4	
28		26.0	22.7	17.5	13.5	10.0	7.0	4.8
30		24.1	21.7	17.0	13.2	9.7	6.8	4.6
32		22.6	20.9	16.6	12.8	9.5	6.7	4.5
44		21.0	19.7	16.0	12.6	9.3	6.5	4.4
55			10.6	11.2	11.1	8.3	5.7	3.7
60				7.5	8.6	7.4	4.9	3.1
70					7.4	6.9	4.7	2.8
75						5.7	4.1	2.2
80							3.8	
85							3.5	

Main boom 43.4 m

Radius (m)	Jib length in (m)							
	20	29	41	53	62	71	83	95
8.8	t	t	t	t	t	t	t	t
11	64.8							
14	62.8	48.7						
16	54.8	45.5	31.5					
18	48.0	41.8	29.1	20.7				
20	42.4	39.1	27.3	19.9	15.9			
22	36.8	34.9	25.8	19.0	15.4	10.8		
26	32.7	31.0	24.3	18.2	14.1	10.5	7.2	
28		25.4	22.0	17.0	13.1	9.7	6.8	4.6
32		23.2	20.9	16.6	12.8	9.5	6.7	4.5
44		20.5	18.9	15.6	12.2	9.1	6.3	4.3
55			9.0	9.6	10.9	8.1	5.6	3.6
60				6.4	6.9	7.2	4.9	3.0
70					6.0	6.7	4.6	2.7
75						5.2	4.0	2.2
80							3.8	
85							3.4	

Main boom 49.1 m

Radius (m)	Jib length in (m)							
	20	29	41	53	62	71	83	95
9	t	t	t	t	t	t	t	t
11	55.9							
14	55.3	43.1						
16	50.2	41.3	28.9					
18	42.0	38.8	27.3	19.3				
20	38.7	35.6	25.8	18.7	14.1			
24	33.9	32.0	24.5	18.0	13.8	10.2		
26	15.1	25.8	22.2	16.7	12.8	9.5	6.7	
28		23.5	20.8	16.2	12.4	9.3	6.5	4.4
32		21.7	19.5	15.8	12.1	9.0	6.4	4.3
44		19.3	17.5	14.0	11.6	8.7	6.1	4.1
55			7.4	9.1	10.0	7.8	5.4	3.4
60				5.9	6.0	6.8	4.7	2.9
70					5.4	6.1	4.4	2.6
75						4.8	3.8	2.1
80							3.5	
85							3.1	

Main boom 55.1 m

Radius (m)	Jib length in (m)							
	20	29	41	53	62	71	83	95
9.2	t	t	t	t	t	t	t	t
12	50.4							
14	49.6	38.9						
17	45.9	37.7	26.9					
18	38.1	34.2	25.2	18.2				
20	36.0	32.8	24.5	17.9	13.3			
24	31.8	28.5	23.4	17.2	13.1	9.7		
26	25.6	24.2	21.1	15.9	12.2	9.1	6.5	
28		22.2	19.9	15.5	11.8	8.9	6.3	4.2
32		20.6	18.5	15.1	11.6	8.7	6.1	4.1
44		18.4	16.5	13.3	11.0	8.3	5.9	3.9
55			6.7	8.3	9.3	7.5	5.2	3.3
60				5.1	5.5	6.4	4.5	2.8
70					4.8	5.6	4.3	2.5
80						4.3	3.6	2.1
85							2.9	
85							2.5	

Main boom 60.8 m

Radius (m)	Jib length in (m)				
	20	29	35	41	50
9.4	t	t	t	t	t
12	43.5				
13	42.2	34.0			
14	40.9	33.5	28.6		
16	39.4	32.9	28.2	24.2	
17	35.6	31.6	27.2	23.4	18.5
18	33.7	30.1	26.7	23.0	18.4
19	32.1	27.8	26.1	22.4	18.0
20	30.4	27.1	24.9	22.0	17.7
22	27.0	25.8	23.9	21.6	17.4
24	24.9	23.5	22.4	20.1	16.8
32	23.2	21.8	20.5	19.0	16.3
38		16.9	15.8	12.1	12.6
44			6.8	8.1	10.2
48				5.8	7.4
50					6.1
55					5.5

Capacities in metric tons with luffing jib (No. 1916.xx) 85.5 t counterweight + 36 t carbody counterweight. Above lift chart is for reference only. For actual lift duty and complete chart with all available configurations please refer to lift chart in operator's cab or manual.

Lift chart - luffing jib (No. 1916.xx)

Main boom angle 83°

Main boom 25.7 m

Radius (m)	Jib length in (m)							
	20	29	41	53	62	71	83	95
12.2	76.5	t	t	t	t	t	t	t
15	67.6	52.3	t	t	t	t	t	t
19	54.5	42.5	31.4	t	t	t	t	t
22	46.8	38.7	27.8	20.6	t	t	t	t
24	35.2	36.5	26.2	19.8	t	t	t	t
26	t	34.2	25.0	19.2	15.5	t	t	t
28	t	32.1	23.9	18.6	15.1	10.6	t	t
32	t	26.2	22.1	17.7	13.6	10.1	7.0	t
34	t	15.1	20.7	17.1	13.3	9.9	6.9	t
36	t	t	19.4	16.7	13.1	9.6	6.7	4.5
38	t	t	18.3	16.3	12.8	9.4	6.6	4.3
44	t	t	15.7	15.1	12.0	8.9	6.1	4.0
55	t	t	t	11.1	10.5	8.1	5.3	3.3
65	t	t	t	t	8.0	7.3	4.6	2.8
70	t	t	t	t	t	6.5	4.4	2.5
75	t	t	t	t	t	t	4.1	2.2
85	t	t	t	t	t	t	3.6	t

Main boom 37.4 m

Radius (m)	Jib length in (m)							
	20	29	41	53	62	71	83	95
13.6	67.5	t	t	t	t	t	t	t
17	56.5	47.6	t	t	t	t	t	t
20	48.5	41.5	28.4	t	t	t	t	t
24	40.4	36.2	25.6	18.9	t	t	t	t
26	35.3	34.1	24.5	18.3	13.9	t	t	t
30	t	28.6	22.7	17.4	13.4	9.9	t	t
32	t	27.3	21.9	17.1	13.1	9.7	6.6	t
34	t	25.2	21.1	16.7	12.8	9.5	6.6	t
36	t	t	19.8	16.2	12.6	9.3	6.4	4.2
38	t	t	18.8	15.8	12.4	9.1	6.3	4.2
40	t	t	17.8	15.5	12.1	8.9	6.2	4.1
42	t	t	17.0	15.2	11.9	8.7	6.0	3.9
46	t	t	15.4	12.7	11.5	8.4	5.8	3.7
55	t	t	t	9.7	10.3	7.9	5.2	3.3
65	t	t	t	t	7.6	7.3	4.6	2.7
75	t	t	t	t	t	6.1	4.1	2.2
85	t	t	t	t	t	t	3.6	t

Main boom 43.4 m

Radius (m)	Jib length in (m)							
	20	29	41	53	62	71	83	95
14.3	61.4	t	t	t	t	t	t	t
17	53.8	44.3	t	t	t	t	t	t
22	42.5	38.4	26.5	t	t	t	t	t
24	39.2	35.8	25.2	18.2	t	t	t	t
26	35.6	33.7	24.1	17.8	t	t	t	t
28	t	31.3	23.3	17.4	13.3	t	t	t
30	t	27.9	22.4	17.0	13.0	9.6	t	t
32	t	26.8	21.6	16.7	12.8	9.4	t	t
34	t	25.0	21.0	16.4	12.5	9.2	6.4	t
36	t	23.2	19.8	15.9	12.3	9.1	6.3	t
38	t	t	18.8	15.6	12.1	8.9	6.2	4.1
48	t	t	9.2	10.7	10.9	8.2	5.6	3.6
55	t	t	t	8.2	8.5	7.8	5.1	3.3
65	t	t	t	t	6.1	7.2	4.6	2.7
75	t	t	t	t	t	5.3	4.1	2.2
85	t	t	t	t	t	t	3.6	t

Main boom 49.1 m

Radius (m)	Jib length in (m)							
	20	29	41	53	62	71	83	95
15	52.6	t	t	t	t	t	t	t
18	47.7	39.8	t	t	t	t	t	t
22	39.3	35.1	25.3	t	t	t	t	t
26	33.1	30.5	23.1	17.1	t	t	t	t
28	30.2	28.3	22.4	16.6	12.6	t	t	t
30	t	26.5	21.6	16.3	12.4	9.1	t	t
32	t	24.9	20.8	16.0	12.2	9.1	t	t
34	t	23.5	20.2	15.7	12.0	8.9	6.1	t
36	t	22.0	19.4	15.3	11.7	8.7	6.1	t
38	t	t	18.4	14.0	11.6	8.6	5.9	3.9
40	t	t	17.6	13.6	11.4	8.4	5.8	3.8
48	t	t	8.0	9.8	10.6	7.9	5.4	3.5
60	t	t	t	5.9	6.8	7.2	4.7	2.9
65	t	t	t	t	5.8	6.8	4.5	2.6
75	t	t	t	t	t	5.0	4.0	2.2
85	t	t	t	t	t	t	3.5	t

Main boom 55.1 m

Radius (m)	Jib length in (m)							
	20	29	41	53	62	71	83	95
15.8	46.5	t	t	t	t	t	t	t
19	40.6	35.4	t	t	t	t	t	t
22	35.5	31.6	23.7	t	t	t	t	t
26	30.9	27.2	22.2	16.2	t	t	t	t
28	28.5	25.8	21.4	16.0	11.9	t	t	t
32	t	23.3	19.8	15.4	11.6	8.7	t	t
36	t	21.0	18.4	13.9	11.2	8.4	5.8	t
38	t	t	17.6	13.5	11.1	8.3	5.7	3.7
46	t	t	8.5	10.7	10.2	7.8	5.3	3.4
48	t	t	7.6	9.5	10.1	7.7	5.2	3.3
60	t	t	t	5.6	5.8	6.6	4.6	2.8
65	t	t	t	t	5.1	6.0	4.3	2.6
75	t	t	t	t	t	4.6	3.8	2.1
80	t	t	t	t	t	t	3.6	t
85	t	t	t	t	t	t	3.4	t
90	t	t	t	t	t	t	3.1	t

Main boom 60.8 m

Radius (m)	Jib length in (m)							
	20	29	35	41	50			
16.5	38.4	t	t	t	t	t	t	t
20	33.7	28.8	t	t	t	t	t	t
22	30.7	26.9	24.5	t	t	t	t	t
24	28.3	25.1	23.0	20.7	t	t	t	t
26	26.7	23.6	21.6	19.7	16.7	t	t	t
28	25.5	22.4	20.6	18.8	16.3	t	t	t
34	t	19.7	18.0	16.7	14.2	t	t	t
36	t	18.9	17.4	16.1	13.6	t	t	t
38	t	18.1	16.8	15.5	13.0	t	t	t
40	t	t	16.2	11.2	12.5	t	t	t
42	t	t	15.6	9.7	12.1	t	t	t
44	t	t	7.4	8.5	10.7	t	t	t
46	t	t	t	7.7	9.5	t	t	t
48	t	t	t	7.0	8.3	t	t	t
50	t	t	t	6.3	7.3	t	t	t
55	t	t	t	t	6.0	t	t	t

Capacities in metric tons with luffing jib (No. 1916.xx) 85.5 t counterweight + 36 t carbody counterweight. Above lift chart is for reference only. For actual lift duty and complete chart with all available configurations please refer to lift chart in operator's cab or manual.

Lift chart – luffing jib (No. 1916.xx)

Main boom angle 75°

Main boom 25.7 m

Radius (m)	Jib length in (m)							
	20	29	41	53	62	71	83	95
18.4	t	t	t	t	t	t	t	t
24	54.4	41.2	39.7					
28	34.0	33.8	25.7					
34		26.6	22.8	18.0				
36		24.8	22.0	17.5				
38			20.6	17.1	13.2			
40			19.3	16.7	12.9	9.4		
46			16.6	15.6	12.2	8.9	6.1	
48			15.7	15.3	12.0	8.8	6.0	
50				14.0	11.8	8.6	5.8	3.7
55				12.9	11.1	8.3	5.5	3.5
60				11.3	10.6	8.0	5.2	3.2
65					9.5	7.7	4.9	2.9
75						6.8	4.3	2.4
80							4.1	2.1
90							3.6	

Main boom 37.4 m

Radius (m)	Jib length in (m)							
	20	29	41	53	62	71	83	95
21.4	t	t	t	t	t	t	t	t
26	41.9	34.6	32.9					
32	15.1	26.8	24.1					
36		23.7	22.3	17.1				
40			20.7	16.5	12.4			
44				18.0	15.8	12.1	8.8	
48				16.1	15.1	11.7	8.5	5.7
50				15.2	13.8	11.6	8.4	5.7
55					12.7	11.1	8.1	5.4
60					11.1	10.7	7.9	5.1
70						8.6	7.5	4.6
75							7.1	4.4
80							6.7	4.2
85								4.0
90								3.8
95								

Main boom 43.4 m

Radius (m)	Jib length in (m)							
	20	29	41	53	62	71	83	95
22.9	t	t	t	t	t	t	t	t
28	36.8	28.8						
32	26.6	25.3	23.6					
38		21.3	19.8	16.4				
42		18.9	17.8	16.0	12.0			
46			16.2	14.3	11.7	8.5		
48			15.5	14.0	11.5	8.4		
50			13.6	13.5	11.4	8.3	5.5	
55				12.2	11.0	8.0	5.4	3.3
60				10.6	10.0	7.8	5.1	3.2
65				8.2	9.2	7.6	4.9	2.9
70					8.0	7.4	4.6	2.7
75						6.9	4.4	2.5
80						6.2	4.2	2.3
85							4.0	2.0
90							3.8	

Main boom 49.1 m

Radius (m)	Jib length in (m)							
	20	29	41	53	62	71	83	95
24.4	t	t	t	t	t	t	t	t
30	32.6	25.3						
34	23.7	22.4	20.8					
40		19.0	17.6	15.6				
42			18.1	16.7	15.2			
44				15.9	14.3	11.3		
46				15.2	13.8	11.2	8.1	
55				9.9	11.1	10.6	7.8	5.2
60					9.5	9.5	7.6	5.0
65					7.9	8.5	7.3	4.7
70						7.5	6.9	4.6
75						6.3	6.3	4.3
80							5.7	4.1
85								3.9
90								3.7
95								3.3

Main boom 55.1 m

Radius (m)	Jib length in (m)							
	20	29	41	53	62	71	83	95
26	t	t	t	t	t	t	t	t
30	28.6	23.6						
36	20.9	19.7	18.2					
40		17.7	16.3	13.9				
44		16.0	14.8	13.5	10.6			
48			13.3	12.3	10.5	7.7		
55			9.8	10.4	9.7	7.5	5.0	
60				9.0	8.7	7.3	4.8	3.0
65				7.6	7.7	7.0	4.6	2.8
75					5.9	5.6	4.2	2.4
85						4.5	3.6	2.0
95							2.7	

Main boom 60.8 m

Radius (m)	Jib length in (m)				
	20	29	35	41	50
27.4	t	t	t	t	t
32	25.3	20.6			
34	21.8	19.4	18.6		
38	14.7	17.3	16.6	16.0	
42		15.6	14.9	14.4	12.8
44		13.6	14.2	13.7	12.4
46		11.8	13.5	13.0	12.1
48			12.8	12.4	11.6
50			11.3	11.8	11.1
55				9.6	9.9
60					8.6
65					7.1

Capacities in metric tons with luffing jib (No. 1916.xx) 85.5 t counterweight + 36 t carbody counterweight. Above lift chart is for reference only. For actual lift duty and complete chart with all available configurations please refer to lift chart in operator's cab or manual.

Lift chart - luffing jib (No. 1916.xx)

Main boom angle 65°

Main boom 25.7 m

Radius (m)	Jib length in (m)							
	20	29	41	53	62	71	83	95
25.6	t	t	t	t	t	t	t	t
30	35.9							
32	27.3	26.9						
38		21.8	21.2					
40		20.4	19.9					
42		15.1	18.7					
46			16.7	16.1				
50			14.8	14.4	11.8			
55				12.7	11.5	8.2		
65				10.0	9.6	7.8	5.0	
70					8.6	7.6	4.8	2.8
75						7.2	4.5	2.6
80						6.5	4.3	2.3
85							4.1	2.1
90							3.9	

Main boom 37.4 m

Radius (m)	Jib length in (m)							
	20	29	41	53	62	71	83	95
30.5	t	t	t	t	t	t	t	t
36	26.5							
38	21.7	21.2						
44	20.2	19.9	15.9					
46		15.6	15.0					
50			13.5	12.6				
55			11.8	11.2	10.5			
60				9.9	9.4	7.7		
65				8.8	8.4	7.6		
70				7.8	7.5	6.8	4.7	
75					6.7	6.1	4.5	2.6
80						5.5	4.4	2.4
85						4.8	4.0	2.2
90							3.6	
95							3.1	

Main boom 43.4 m

Radius (m)	Jib length in (m)							
	20	29	41	53	62	71	83	95
33.1	t	t	t	t	t	t	t	t
40	22.4							
46	17.9	17.3						
48		14.7	13.7					
55		13.9	13.0					
60			11.0	10.0				
65			9.7	9.0	8.3			
70				8.1	7.4	6.6		
80				7.2	6.6	5.8	4.6	
85					5.4	4.6	3.7	2.4
90						4.1	3.2	2.2
100						3.7	2.8	
							2.0	

Main boom 49.1 m

Radius (m)	Jib length in (m)							
	20	29	41	53	62	71	83	
35.5	t	t	t	t	t	t	t	
40	19.1							
42	16.8							
48	15.9	15.0						
50		12.9	11.7					
55		12.3	11.2					
60			10.0	8.9				
65			9.0	7.9	7.2			
75				7.1	6.4	5.6		
80				5.8	5.1	4.3	3.4	
85					4.6	3.8	2.9	
90						3.3	2.4	
						2.9	2.0	

Main boom 55.1 m

Radius (m)	Jib length in (m)							
	20	29	41	53	62	71	83	
38	t	t	t	t	t	t	t	
44	15.9							
50	13.6	12.6						
55		10.9						
60			8.7					
65			7.7	6.7				
70			7.0	6.0	5.3			
75				5.3	4.7	3.8		
85				4.7	4.1	3.3	2.4	
90					3.2	2.4		
						2.1		

Main boom 60.8 m

Radius (m)	Jib length in (m)							
	20	29	35	41	50			
40.4	t	t	t	t	t			
44	13.1							
46	12.0							
48	11.4	10.5						
50	10.9	10.0						
55		9.5	8.9					
60		8.5	7.9	7.4				
65			7.1	6.6	5.9			
70				5.9	5.2			
75					4.6			
					4.1			

Capacities in metric tons with luffing jib (No. 1916.xx) 85.5 t counterweight + 36 t carbody counterweight. Above lift chart is for reference only. For actual lift duty and complete chart with all available configurations please refer to lift chart in operator's cab or manual.

Lift chart – luffing jib (No. 1916.xx)

Main boom angle 45°

Main boom 25.7 m

Radius (m)	Jib length in (m)						
	20	29	41	53	62	71	83
t	t	t	t	t	t	t	t
37.7	19.9						
40	18.4						
46		15.1					
48		14.2					
55			11.3				
60			10.0				
65				8.4			
70				7.5			
75					6.3		
80					5.6	5.1	
90						3.9	3.4
100							2.5

Main boom 37.4 m

Radius (m)	Jib length in (m)					
	20	29	41	53	62	71
t	t	t	t	t	t	t
46	12.8					
48	12.2					
55		9.7				
65			7.0			
75				4.9		
80				4.3		
85					3.4	
90						2.4
95						2.0

Main boom 43.4 m

Radius (m)	Jib length in (m)				
	20	29	41	53	62
t	t	t	t	t	t
50.2	10.0				
60		7.3			
70			5.1		
80				3.4	
85				2.9	2.3

Main boom 49.1 m

Radius (m)	Jib length in (m)		
	20	29	41
t	t	t	t
54.2	7.7		
55	7.6		
65		5.4	
75			3.5

Main boom 55.1 m

Radius (m)	Jib length in (m)	
	20	29
t	t	t
58.5	5.5	
60	5.3	
70		3.4

Main boom 60.8 m

Radius (m)	Jib length in (m)
	20
t	t
62.5	3.4
65	3.2

Capacities in metric tons with luffing jib (No. 1916.xx) 85.5 t counterweight + 36 t carbody counterweight. Above lift chart is for reference only. For actual lift duty and complete chart with all available configurations please refer to lift chart in operator's cab or manual.

Working range - fixed jib (No. 1008.xx) 15° and 30°

Main boom 88° - 30°

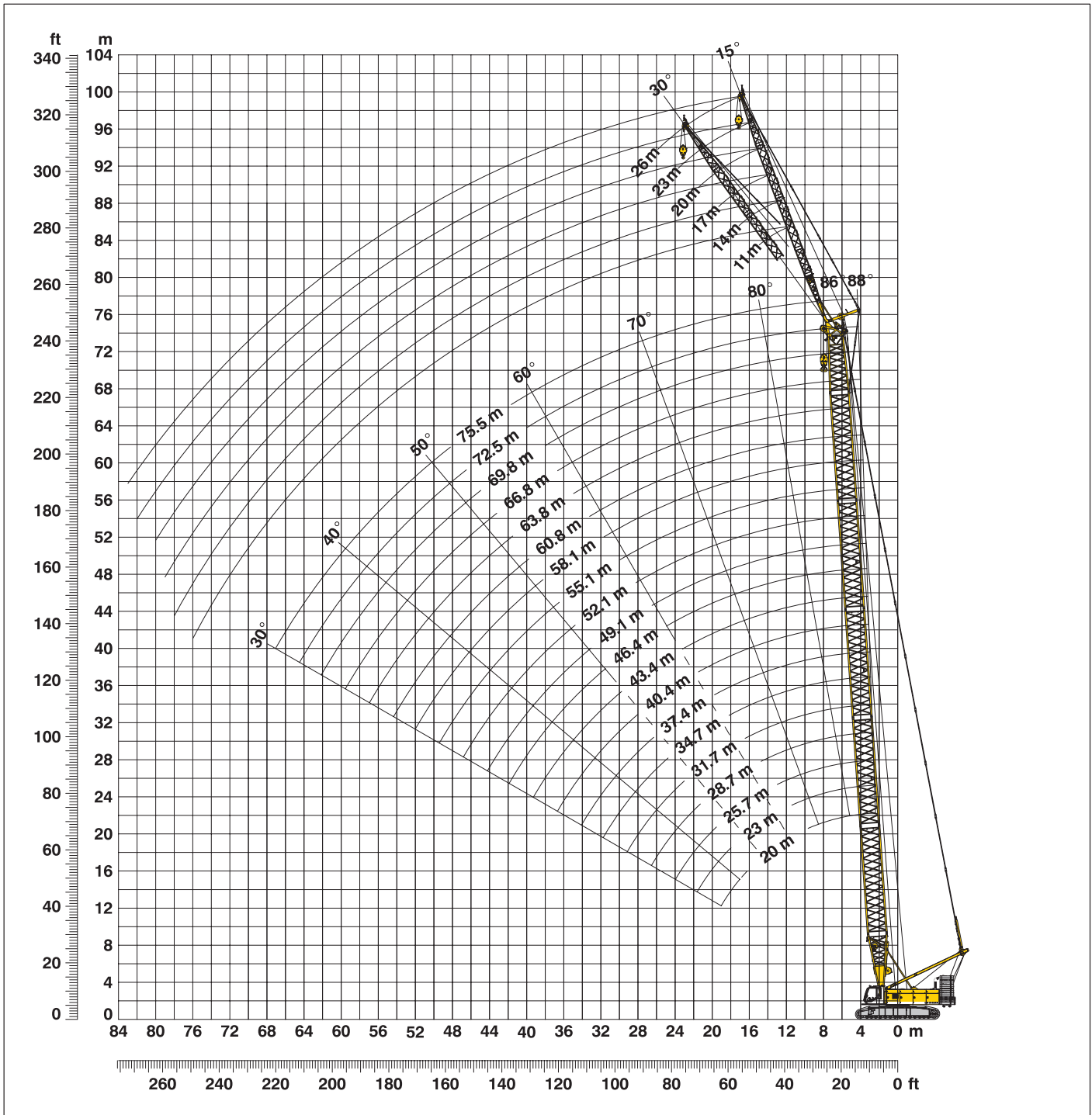

Boom configuration for boom lengths (20 m - 75.5 m) – see table 1 on page 10

Fixed jib configuration for fixed jib lengths (11 m - 26 m)

	Length	Amount of fixed jib extensions					
Fixed jib foot	5.5 m	1	1	1	1	1	1
Fixed jib insert	3.0 m		1		1		1
Fixed jib insert	6.0 m			1	1	2	2
Fixed jib head	5.5 m	1	1	1	1	1	1
Fixed jib length (m)		11	14	17	20	23	26

Lift chart – fixed jib (No. 1008.xx)

Offset 15°

Main boom 20 m

Radius (m)	Fixed jib length in (m)			
	11	14	20	26
5.8	t	t	t	t
7	36.8	36.8		
10	36.7	36.8	30.1	
12	36.7	36.8	26.9	18.9
16	35.5	31.0	23.3	16.4
20	32.1	26.0	19.0	13.3
24	27.3	22.1	16.2	11.8
28	24.2	19.2	14.6	10.7
30	22.7	18.1	13.6	10.3
32		17.1	12.8	9.9
38			10.9	8.4
44				7.4

Main boom 28.7 m

Radius (m)	Fixed jib length in (m)			
	11	14	20	26
6.1	t	t	t	t
8	36.8	36.8		
10	36.8	36.8	29.0	
12	36.8	36.8	27.1	18.7
16	36.8	34.4	23.8	16.5
20	34.8	29.9	20.7	13.7
28	27.8	22.5	15.8	11.4
30	26.8	21.1	15.1	11.0
38	20.5	17.4	12.6	9.5
40		16.7	12.0	9.0
46			10.6	7.9
50				7.4

Main boom 37.4 m

Radius (m)	Fixed jib length in (m)			
	11	14	20	26
6.4	t	t	t	t
8	36.7	36.7		
10	36.7	36.8	28.4	
13	36.8	36.7	26.2	18.0
20	36.8	31.7	22.0	13.9
28	31.4	25.2	17.2	11.8
32	25.9	22.6	15.5	11.1
40	18.5	18.8	13.5	9.9
44	15.8	16.2	12.4	9.1
48		14.0	11.5	8.4
50			11.1	8.2
60				7.1

Main boom 46.4 m

Radius (m)	Fixed jib length in (m)			
	11	14	20	26
6.8	t	t	t	t
8	36.7	36.7		
11	36.7	36.8	27.3	
13	36.7	36.8	26.0	17.7
20	36.7	34.1	22.0	15.1
24	36.8	29.6	20.1	12.8
30	27.7	26.2	17.6	11.7
40	17.7	18.1	14.8	10.3
50	12.0	12.3	12.3	8.9
55		10.2	10.8	8.2
60			9.0	7.7
65				7.3

Main boom 55.1 m

Radius (m)	Fixed jib length in (m)			
	11	14	20	26
7.1	t	t	t	t
9	36.7	36.7		
11	36.7	36.7	26.5	
13	36.7	36.7	25.5	17.2
20	36.1	35.1	21.9	15.1
24	33.7	31.7	20.5	12.9
30	26.3	26.5	18.2	11.9
40	17.1	17.4	15.2	10.6
50	11.4	11.7	12.3	9.6
60	7.5	7.8	8.4	8.2
70			5.6	6.1
75				4.9

Main boom 60.8 m

Radius (m)	Fixed jib length in (m)			
	11	14	20	26
7.3	t	t	t	t
9	36.6	34.7		
11	36.8	34.9	25.6	
14	36.7	34.9	24.4	16.7
20	36.8	34.5	21.6	13.7
30	25.3	25.5	18.4	11.9
40	16.6	17.0	15.8	10.7
50	10.9	11.2	11.9	9.7
60	7.1	7.4	8.0	8.5
65	5.6	5.9	6.5	7.0
75			4.0	4.5
80				3.5

Main boom 66.8 m

Radius (m)	Fixed jib length in (m)			
	11	14	20	26
7.5	t	t	t	t
9	35.6	32.0		
11	35.7	32.0	24.2	
14	35.2	31.9	23.8	16.3
20	34.3	31.4	21.3	13.6
30	24.1	24.3	18.5	11.8
40	15.8	16.0	16.3	10.7
50	10.4	10.7	11.3	9.8
60	6.6	6.9	7.5	8.0
70	3.9	4.1	4.7	5.2
80			2.6	3.0
85				2.1

Main boom 72.5 m

Radius (m)	Fixed jib length in (m)			
	11	14	20	26
7.7	t	t	t	t
9	32.1	27.0		
12	31.5	27.0	22.0	
18	30.4	26.4	20.9	13.7
20	28.5	25.9	20.6	13.2
30	23.0	22.0	18.2	11.6
40	14.5	15.1	15.6	10.6
50	9.8	10.1	10.5	9.8
60	6.1	6.4	7.0	7.3
70	3.4	3.7	4.3	4.7
75	2.4	2.6	3.1	3.6
80			2.2	2.6

Main boom 75.5 m

Radius (m)	Fixed jib length in (m)		
	11	14	17
7.8	t	t	t
9	30.6	26.0	
11	30.2	25.8	23.3
20	27.0	24.6	22.2
30	21.9	21.0	19.8
40	13.9	14.1	14.7
50	9.4	9.6	9.9
55	7.5	7.7	8.0
60	5.9	6.1	6.4
65	4.4	4.7	5.0
70	3.2	3.4	3.7
75	2.1	2.3	2.6

Capacities in metric tons with fixed jib (No. 1008.xx) 85.5 t counterweight + 36 t carbody counterweight. Above lift chart is for reference only. For actual lift duty and complete chart with all available configurations please refer to lift chart in operator's cab or manual.

Lift chart - fixed jib (No. 1008.xx)

Offset 30°

Main boom 20 m

Radius (m)	Fixed jib length in (m)			
	11	14	20	26
8.5	36.8			
11	34.4	27.9		
14	29.6	23.8	17.0	
18	25.6	19.9	14.9	11.9
20	23.7	18.6	14.1	10.9
24	20.9	16.5	12.2	9.3
26	19.8	15.6	11.4	8.7
28	19.0	15.1	10.7	8.2
30	18.4	15.1	10.1	7.8
34		14.2	9.2	7.1
40			8.5	6.3
46				5.9

Main boom 28.7 m

Radius (m)	Fixed jib length in (m)			
	11	14	20	26
8.8	36.8			
11	35.2	28.1		
15	30.1	23.8	16.5	
18	27.7	21.4	15.1	11.7
20	26.3	20.0	14.5	11.1
24	23.3	17.9	13.0	9.6
28	21.2	16.4	11.7	8.6
30	20.3	15.7	11.0	8.2
38	18.2	14.6	9.3	7.0
40		14.3	9.0	6.8
46			8.6	6.2
50				6.0

Main boom 37.4 m

Radius (m)	Fixed jib length in (m)			
	11	14	20	26
9.1	36.6			
11	36.3	28.1		
15	31.3	24.5	16.5	
19	28.7	21.7	15.1	11.5
20	27.8	21.2	15.0	11.1
28	23.0	17.5	12.3	9.0
30	22.2	16.8	11.8	8.6
40	18.7	14.9	9.7	7.2
46	14.8	14.4	8.9	6.6
48		14.1	8.8	6.4
55			8.4	6.0
60				5.9

Main boom 46.4 m

Radius (m)	Fixed jib length in (m)			
	11	14	20	26
9.4	36.7			
12	35.4	27.3		
15	32.4	24.9	16.4	
19	30.1	22.4	15.1	11.4
20	29.6	21.8	15.1	11.2
28	24.7	18.5	12.9	9.2
30	23.7	17.9	12.3	8.9
40	18.1	15.5	10.3	7.5
50	12.1	12.5	9.1	6.6
55		10.3	8.7	6.3
60			8.5	6.0
65				5.9

Main boom 55.1 m

Radius (m)	Fixed jib length in (m)			
	11	14	20	26
9.7	36.7			
12	35.6	27.3		
16	32.2	24.6	16.2	
19	29.8	23.0	15.2	11.3
20	29.8	22.4	15.1	11.2
28	26.0	19.2	13.3	9.4
30	25.2	18.6	12.8	9.0
40	17.5	16.1	10.9	7.8
50	11.6	12.0	9.5	6.9
60	7.6	8.0	8.7	6.3
70			5.7	5.9
75				5.0

Main boom 60.8 m

Radius (m)	Fixed jib length in (m)			
	11	14	20	26
9.9	33.9			
12	33.8	26.9		
16	32.3	24.8	16.1	
20	29.6	22.7	15.0	11.1
28	26.6	19.6	13.5	9.5
30	25.9	19.0	13.1	9.2
40	17.1	16.6	11.2	7.9
50	11.2	11.6	9.8	7.0
60	7.3	7.6	8.4	6.4
65	5.7	6.1	6.8	6.2
75			4.1	4.7
80				3.6

Main boom 66.8 m

Radius (m)	Fixed jib length in (m)			
	11	14	20	26
10.1	31.1			
12	31.1	24.6		
16	31.0	24.3	16.0	
20	28.1	23.0	15.1	11.1
28	25.4	20.1	13.6	9.6
30	24.4	19.4	13.3	9.3
40	16.3	16.7	11.5	8.1
50	10.7	11.2	10.1	7.2
60	6.8	7.2	7.9	6.6
70	4.0	4.3	5.0	5.6
80			2.7	3.2
85				2.2

Main boom 72.5 m

Radius (m)	Fixed jib length in (m)			
	11	14	20	26
10.3	25.7			
13	25.6	22.6		
16	25.4	22.5	15.9	
20	25.1	22.1	15.1	10.0
28	23.2	20.5	13.7	9.6
30	22.2	19.8	13.3	9.4
40	15.5	15.9	11.7	8.2
50	10.2	10.6	10.4	7.4
60	6.4	6.8	7.5	6.7
70	3.6	3.9	4.6	5.2
75	2.4	2.8	3.4	4.0
80			2.3	2.9

Main boom 75.5 m

Radius (m)	Fixed jib length in (m)			
	11	14	17	
10.4	24.5			
13	24.4	21.5		
15	24.3	21.6	19.7	
20	23.8	21.4	18.1	
28	22.2	20.4	16.2	
30	21.2	19.8	15.9	
38	16.3	16.8	14.6	
40	14.3	15.4	14.4	
50	9.8	10.2	10.6	
60	6.1	6.5	6.8	
70	3.3	3.7	4.0	
75	2.2	2.5	2.9	

Capacities in metric tons with fixed jib (No. 1008.xx) 85.5 t counterweight + 36 t carbody counterweight. Above lift chart is for reference only. For actual lift duty and complete chart with all available configurations please refer to lift chart in operator's cab or manual.

Notice

